

ZH8056 (One Motor)

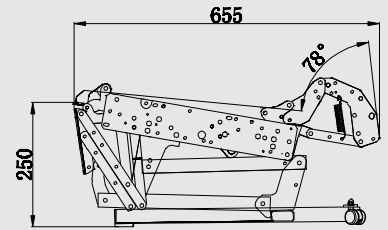

0 Position

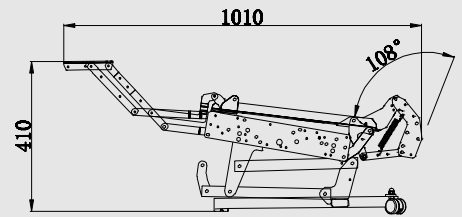

Relax Position

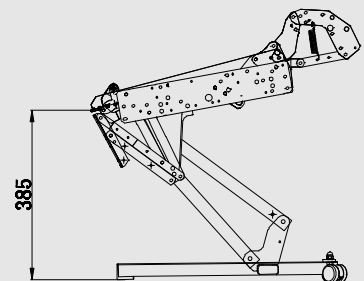

Lift Position

Key Features & Benefits

- Using one motor to drive the mechanism, making the mechanism obtain the functions of sitting, lying on back and lifting the seat; The motor controls the footrest, lift action and back rest simultaneously;
- Very convenient for adjust the posture at any location by motor;
- When lifting, the frame raising parallelly to the ground then inclining;
- Available in any width for sofa seat,only need to change some parts of the mechanism;
- The center of gravity of the mechanism can maintain its balance under different conditions, enhancing mechanism's ground-graping capacity;
- KD plug between backrest and seat frame is convenient for sofa to be disassembled, installed and transported;
- Connection angle iron is the best choice for you to make high quality lift recliner chairs but less labor cost;
- All rivet joints have acetal washers to eliminate any steel-to-steel contact;No metal-to-metal noises when links stop.



Changzhou Zehui Machinery Co., Ltd
Industry Zone,Zhaigiao,Qianhuang Town,Wujin
District,Jiangsu Province,China

0519-83335279

www.zehuiliftchair.com

sales@zehuiliftchair.com

ZH8057 (Two Motors)

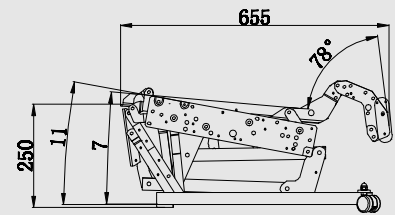

0 Position

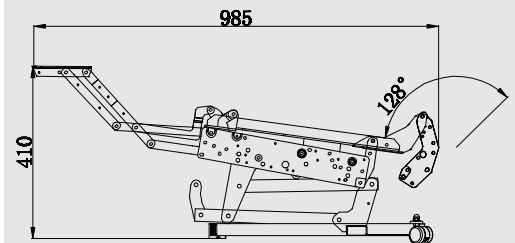

Relax Position

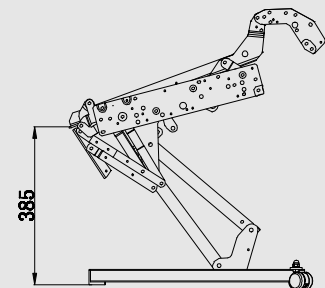

Lift Position

Key Features & Benefits

- Using two motors to drive the mechanism, one motor works simultaneously for the footrest and lift action, the other controls the back rest alone;
- Operation is easier and more convenient.Using the electrical control panel can realise different laying gestures;
- When lifting, the frame raising parallelly to the ground then inclining;
- Many kinds of electrical control panels are available;
- The center of gravity of the mechanism can maintain its balance under different conditions, enhancing mechanism's ground-graping capacity;
- KD plug between backrest and seat frame is convenient for sofa to be disassembled, installed and transported;
- Connection angle iron is the best choice for you to make high quality lift recliner chairs but less labor cost;
- Strengthening the adhesive of the paint on the mechanism to prevent getting rusty;
- All rivet joints have acetal washers to eliminate any steel-to-steel contact;No metal-to-metal noises when links stop.

Changzhou Zehui Machinery Co., Ltd
Industry Zone,Zhaigiao,Qianhuang Town,Wujin
District,Jiangsu Province,China

0519-83335279

www.zehuilightchair.com

sales@zehuilightchair.com

Motorized-Lift Chair Mechanism Series

ZH8057L(Two Motor)



Key Feature& Benefits

- Using two motors to drive the mechanism, one motor works simultaneously for the footrest and lift action, the other controls the back rest alone;
- Operation is easier and more convenient. Using the electrical control panel can realize different laying gestures;
- When the mechanism do the lift action, first raising vertically to the ground then inclining;
- Many kinds of electrical control panels are available;
- The center of gravity of the mechanism can maintain its balance under different conditions, enhancing mechanism's ground-graping capacity;
- KD plug between backrest and seat frame is convenient for sofa to be disassembled, installed and transported;
- Connection angle iron is the best choice for you to make high quality lift recliner chairs but less labor cost;
- Strengthen the adhesive of the paint on the mechanism to prevent getting rusty;

ZH8070 (One Motor)

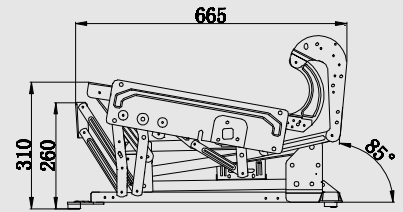

0 Position

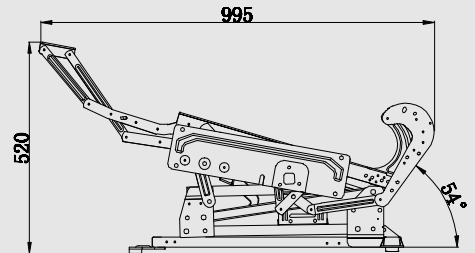

Relax Position

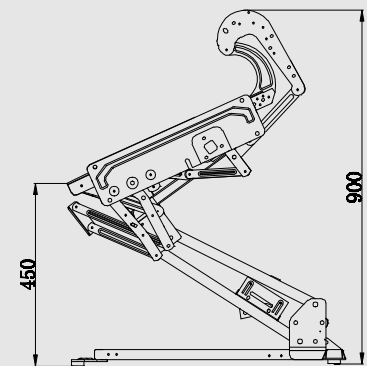

Lift Position

Key Features & Benefits

- Using one motor to control the footrest, lift action and back rest simultaneously, making the mechanism obtain the functions of sitting, lying on back and lifting the seat;
- This is backrest and footrest linkage mechanism;
- Very convenient for adjust the posture at any location by motor;
- The mechanism do lifting and inclining function at the same time;
- For the width and motor switch of a product, various specifications are available for selection;
- The center of gravity of the mechanism can maintain its balance under different conditions, enhancing mechanism's ground-graping capacity;
- KD plug between backrest and seat frame is convenient for sofa to be disassembled, installed and transported;
- All rivet joints have acetal washers to eliminate any steel-to-steel contact; No metal-to-metal noises when links stop.

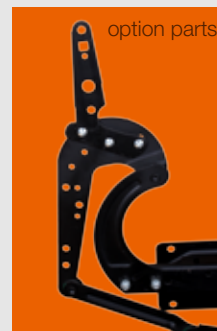

option parts

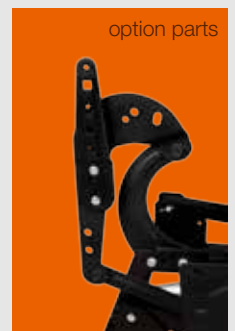

option parts

Changzhou Zehui Machinery Co., Ltd
Industry Zone, Zhaigiao, Qianhuang Town, Wujin
District, Jiangsu Province, China

0519-83335279

www.zehuiliftchair.com

sales@zehuiliftchair.com

Motorized-Lift Chair Mechanism Series

ZH8070L(One Motor)



Key Feature& Benefits

a.Using one motor to control the footrest, lift action and back rest simultaneously, making the mechanism obtain the functions of sitting, lying on back and lifting the seat;

b.Very convenient for adjust the posture at any location by motor;

c.The mechanism do lifting and inclining function at the same time;

d.For the width and motor switch of a product, various specifications are available for selection;

e.The center of gravity of the mechanism can maintain its balance under different conditions, enhancing mechanism's ground-graping capacity;

f.Manual or Power version is available.

Motorized-Lift Chair Mechanism Series

ZH8070-GJ(One Motor)



Key Feature& Benefits

- a. Using one motor to control the footrest, back rest and lift action;
- b. This is backrest and footrest linkage mechanism;
- c. The mechanism do lifting and inclining function at the same time;
- d. KD back brackets allow easily for packing and shipping;
- e. The design of incorporate with handle and seat frame improve installation efficiency.
- f. Obtain a TÜV certification via KuKa.

ZH8071 (Two Motors)



Electrical shutoff switch
When you use the trolley, power is off;
When you don't use the trolley, power is on.

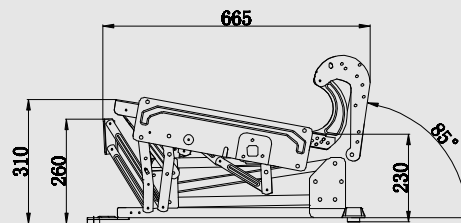

0 Position

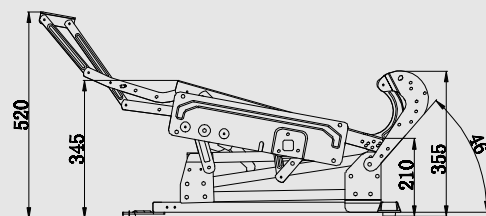

Relax Position

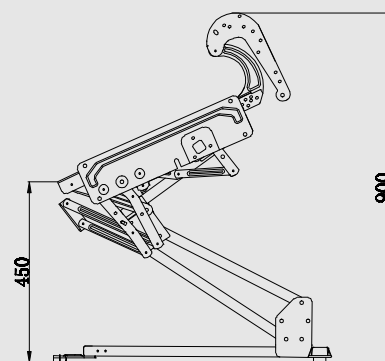

Lift Position

Key Features & Benefits

- Using two motors to drive the mechanism, one motor works simultaneously for the footrest and lift action, the other controls the back rest alone;
- Operation is easier and more convenient. Using the electrical control panel can realise different laying gestures;
- The mechanism do lifting and inclining function at the same time;
- For the width and motor switch of a product, various specifications are available for selection
- The center of gravity of the mechanism can maintain its balance under different conditions, enhancing mechanism's ground-graping capacity;
- KD plug between backrest and seat frame is convenient for sofa to be disassembled, installed and transported;
- Strengthening the adhesive of the paint on the mechanism to prevent getting rusty;
- All rivet joints have acetal washers to eliminate any steel-to-steel contact; No metal-to-metal noises when links stop.



Changzhou Zehui Machinery Co., Ltd
Industry Zone, Zhaigao, Qianhuang Town, Wujin
District, Jiangsu Province, China

0519-83335279

www.zehuiliftchair.com

sales@zehuiliftchair.com

Motorized-Lift Chair Mechanism Series

ZH8071L(Two Motor)



Key Feature& Benefits

- Using two motors to drive the mechanism, one motor works simultaneously for the footrest and lift action, the other controls the back rest alone;
- Operation is easier and more convenient.Using the electrical control panel can realise different laying gestures;
- The mechanism do lifting and inclining function at the same time;
- For the width and motor switch of a product,various specifications are available for selection
- The center of gravity of the mechanism can maintain its balance under different conditions, enhancing mechanism's ground-graping capacity;
- Manual or Power version is available;
- Extensive footrest makes footrest longer.

Motorized-Lift Chair Mechanism Series

ZH8071-GJ(Two Motor)



Key Feature& Benefits

a. Using two motors to drive the mechanism, one motor works simultaneously for the footrest and lift action, the other controls the back rest alone;

b. The backrest can stop at an angle of the inclination range;

c. The mechanism do lifting and inclining function at the same time;

d. KD back brackets allow easily for packing and shipping;

e. The design of incorporate with handle and seat frame improve installation efficiency.

f. Obtain a TÜV certification via KUKA.

g. Max lifting capacity is 330 pound.

ZH8071A (Two Motors)



Key Features & Benefits

- Using two motors to drive the mechanism, one motor works simultaneously for the footrest and lift action, the other controls the back rest alone;
- Operation is easier and more convenient.Using the electrical control panel can realise different laying gestures;
- When lifting, inclining at the same time.
- For the width and motor switch of a product,various specifications are available for selection
- The center of gravity of the mechanism can maintain its balance under different conditions, enhancing mechanism's ground-graping capacity;
- KD plug between backrest and seat frame is convenient for sofa to be disassembled, installed and transported;
- Equipped with universal wheel and trolley system;
- Strengthening the adhesive of the paint on the mechanism to prevent getting rusty;
- All rivet joints have acetal washers to eliminate any steel-to-steel contact;No metal-to-metal noises when links stop.

Changzhou Zehui Machinery Co., Ltd
Industry Zone,Zhaigiao,Qianhuang Town,Wujin
District,Jiangsu Province,China

0519-83335279

www.zehuiliftchair.com

sales@zehuiliftchair.com

Motorized-Lift Chair Mechanism Series

ZH8071A-L(Two Motor)



Key Feature& Benefits

- Using two motors to drive the mechanism, one motor works simultaneously for the footrest and lift action, the other controls the back rest alone;
- Operation is easier and more convenient.Using the electrical control panel can realise different laying gestures;
- When the mechanism do the lift action, lifting while inclining;
- For the width and motor switch of a product,various specifications are available for selection
- The center of gravity of the mechanism can maintain its balance under different conditions, enhancing mechanism's ground-graping capacity;
- Manual or Power version is available.
- Extensive footrest makes footrest longer.

Motorized-Lift Chair Mechanism Series

ZHOEC2(Two Motor)



Key Feature& Benefits

- a. Using two motors to drive the mechanism, one motor works simultaneously for the footrest and lift action, the other controls the back rest alone;
- b. The backrest can stop at an angle of the inclination range;
- c. When lifting, the frame raising parallel to the ground then inclining;
- e. KD back brackets allow easily for packing and shipping;
- f. Series of seat width can be choose, optional -0, -1, -2, -3...
- g. Max lifting capacity is 350 pound

ZH8081



Key Features & Benefits

- ZH8081 is a power lift base;
- Wide Heavy Gauge links.Profile shape designed for safety and appearance without pinch points;
- KD back brackets allow easy back removal for handling;
- All rivet joints have either acetal or Bronze bushing. Acetal spacers to eliminate any steel-to-steel contact.No metal-to-metal noises when links contact stopping;
- Strength the quantity and paste of the paint on the mechanism to prevent getting rusty.



Changzhou Zehui Machinery Co., Ltd
Industry Zone,Zhaigiao,Qianhuang Town,Wujin
District,Jiangsu Province,China

0519-83335279

www.zehuilightchair.com

sales@zehuiliftchair.com

Motorized-Lift Chair Mechanism Series

ZH8046(Two Motor)



Key Feature& Benefits

- Using two motors to drive the mechanism,one motor works simultaneously for the footrest and lift action,the other controls the back rest alone;
- When lifting,the frame raising parallely to the ground then inclining;
- KD back brackets allow easy back removal for handing;
- It's a zero-gravity mechanism;
- Extensive footrest makes footrest longer;

ZH8055

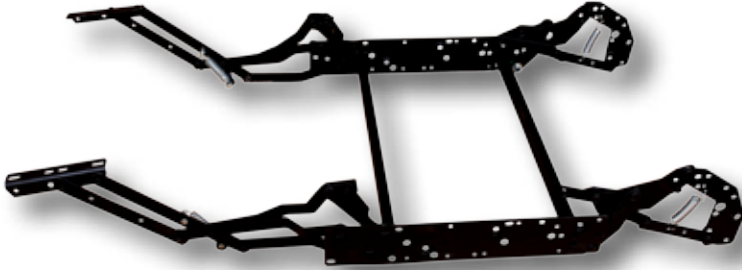

ZH8055A



Key Features & Benefits

- Available in any width for sofa seat, only need to change some parts of the mechanism;
- Open smoothly with a push-on-the-arm mechanism and closes easily with simple leg pressure;
- Geometry used to balance chair operation, occupant's weight is used to balance operation instead of springs. Therefore, the opening, closing, ottoman firmness, and back balance well, reclining varies with the weight of the occupant making the operation consistent from one person to the next. Springs are used for locking and initial start of opening.
- KD plug between backrest and seat frame is convenient for sofa to be disassembled, installed and transported;
- All rivet joints have acetal washers to eliminate any steel-to-steel contact; No metal-to-metal noises when links stop;
- Gas spring back rest version is available.

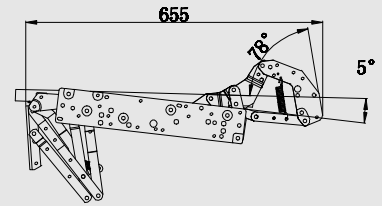

0 Position

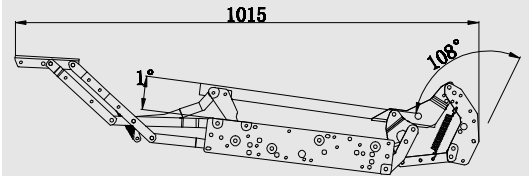

Relax Position

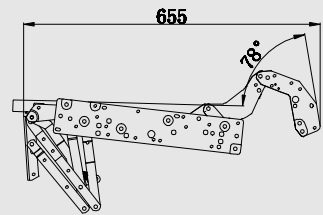

0 Position

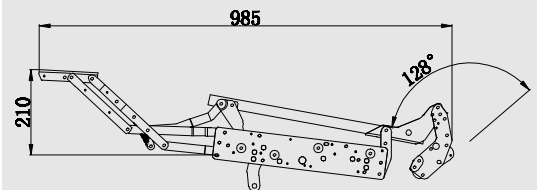

Relax Position

Changzhou Zehui Machinery Co., Ltd
 Industry Zone, Zhaigiao, Qianhuang Town, Wujin
 District, Jiangsu Province, China

0519-83335279

www.zehuilightchair.com

sales@zehuilightchair.com

ZH8056A (One Motor)



ZH8057A (Two Motors)



Key Features & Benefits

- Using motor to drive the mechanism, the motor controls the footrest and back rest;
- Very convenient for adjust the posture at any location by motor;
- Available in any width for sofa seat,only need to change some parts of the mechanism;
- The center of gravity of the mechanism can maintain its balance under different conditions, enhancing mechanism's ground-graping capacity;
- KD plug between backrest and seat frame is convenient for sofa to be disassembled, installed and transported;
- Connection angle iron is the best choice for you to make high quality lift recliner chairs but less labor cost;
- All rivet joints have acetal washers to eliminate any steel-to-steel contact;No metal-to-metal noises when links stop.

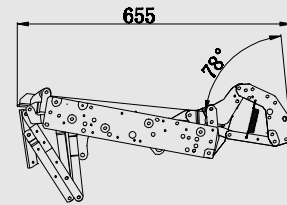

0 Position

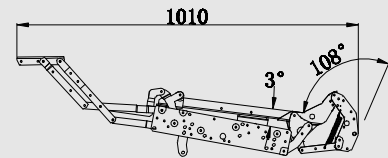

Relax Position

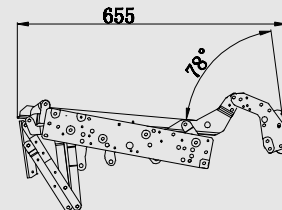

0 Position

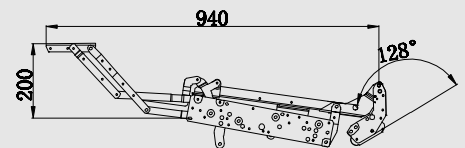

Relax Position

Changzhou Zehui Machinery Co., Ltd
Industry Zone,Zhaigiao,Qianhuang Town,Wujin
District,Jiangsu Province,China

0519-83335279

www.zehuiliftchair.com

sales@zehuiliftchair.com

ZH8061

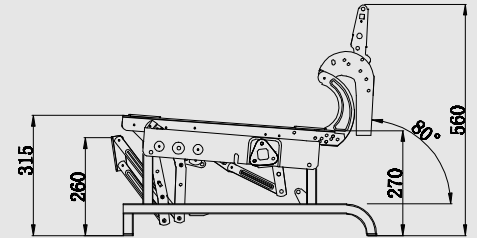

0 Position

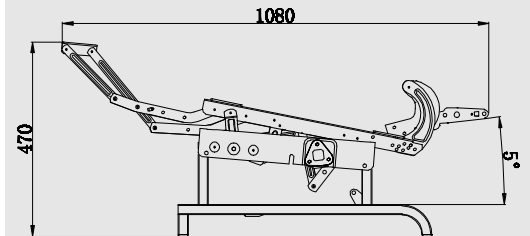

Relax Position

Key Features & Benefits

- Seats are not just designed to be sat on, with ZH8061 Mechanism you are able to comfortably sleep in a natural resting position;
- Very convenient for adjust the posture at any location by motor;
- Available in any width for sofa seat,only need to change some parts of the mechanism;
- The center of gravity of the mechanism can maintain its balance under different conditions, enhancing mechanism's ground-graping capacity;
- KD plug between backrest and seat frame is convenient for sofa to be disassembled, installed and transported;
- All rivet joints have acetal washers to eliminate any steel-to-steel contact;No metal-to-metal noises when links stop;
- Application:Common sofa and sofa bed.

Changzhou Zehui Machinery Co., Ltd
Industry Zone,Zhaigiao,Qianhuang Town,Wujin
District,Jiangsu Province,China

0519-83335279

www.zehuiliftchair.com

sales@zehuiliftchair.com

ZH4151 – Rocker



Key Features & Benefits

- Geometry used to balance chair operation, occupant's weight is used to balance operation instead of springs. Therefore, the opening, closing, ottoman firmness, and back balance well;
- reclining varies with the weight of the occupant making the operation consistent from one person to the next. Spring are used for locking and initial start of opening;
- Handle/lever activated & Gravity operation, Handle/lever used for release only. Occupant's weight opens chair, Handle/lever only unlocks mechanism, slight footrest pressure closes ottoman. Square tube connects both left & right sides. Ottoman is locked closed on both sides;
- Improve weight capacity and durability (250 pound occupant weight). Mechanism base width is closer to seat width while maintaining sufficient clearance between links to eliminate possibility of interference;
- Flat plastic glide allows base to be longer for resistance to tipping over without interfering with chair frame when rocking backward more rock & stouter frames;
- All rivet joints have acetal washers to eliminate any steel-to-steel contact; No metal-to-metal noises when links stop;
- Good painting, strength the adhesive of the paint on the mechanism to prevent getting rusty.

Changzhou Zehui Machinery Co., Ltd
Industry Zone, Zhaigao, Qianhuang Town, Wujin
District, Jiangsu Province, China

0519-83335279

www.zehuiliftchair.com

sales@zehuiliftchair.com

ZH4153- Rocker With Swivel



Key Features & Benefits

- Geometry used to balance chair operation, occupant's weight is used to balance operation instead of springs. Therefore, the opening, closing, ottoman firmness, and back balance well, reclining varies with the weight of the occupant making the operation consistent from one person to the next. Springs are used for locking and initial start of opening;
- Handle/lever activated & Gravity operation, Handle/lever used for release only. Occupant's weight opens chair, Handle/lever only unlocks mechanism, slight footrest pressure closes ottoman. Square tube connects both left & right sides. Ottoman is locked closed on both sides;
- All four glide links blocked while the ottoman is open to eliminate unwanted motion when reclining and to eliminate rearward tipping problems;
- Flatter links support chair;
- Greased full race ball bearing glide joints; Effortless glide motion that does not deteriorate over the life of the mechanism;
- All rivet joints have acetal washers to eliminate any steel-to-steel contact; No metal-to-metal noises when links stop;
- Good painting, strength the adhesive of the paint on the mechanism to prevent getting rusty.

Changzhou Zehui Machinery Co., Ltd
Industry Zone, Zhaigiao, Qianhuang Town, Wujin
District, Jiangsu Province, China

0519-83335279

www.zehuiliftchair.com

sales@zehuiliftchair.com

ZH4181-360° Swivel Glider



Key Features & Benefits

- Geometry used to balance chair operation, occupant's weight is used to balance operation instead of springs. Therefore, the opening, closing, ottoman firmness, and back balance well, reclining varies with the weight of the occupant making the operation consistent from one person to the next. Spring are used for locking and initial start of opening;
- Handle/lever activated & Gravity operation, Handle/lever used for release only. Occupant's weight opens chair, Handle/lever only unlocks mechanism, slight footrest pressure closes ottoman. Square tube connects both left & right sides. Ottoman is locked closed on both sides;
- Two glide links blocked while the ottoman is open to eliminate unwanted motion when reclining and to eliminate rearward tipping problems;
- Flatter links support chair;
- Greased full race ball bearing glide joints; Effortless glide motion that does not deteriorate over the life of the mechanism;
- All rivet joints have acetal washers to eliminate any steel-to-steel contact; No metal-to-metal noises when links stop;
- Good painting, strength the adhesive of the paint on the mechanism to prevent getting rusty;
- Manual or Power version is available.

Changzhou Zehui Machinery Co., Ltd
Industry Zone, Zhaigiao, Qianhuang Town, Wujin
District, Jiangsu Province, China

0519-83335279

www.zehuiliftchair.com

sales@zehuiliftchair.com

ZH8362



Key Features & Benefits

- Headrest or extended ottoman can get maximal and supports to neck area;
- This swivel base bar is made with the roll bearings, in order to deduce the friction and make it more durable;
- It's easier to control different position such as sitting, reclining and laying on the back;
- KD back and KD arms for easy upholstery and less shipment cost;
- You may choose the base with electro plated, painted, stainless steel;
- With or without base, optional for manual and double motors versions.



ZH8362 (Power)

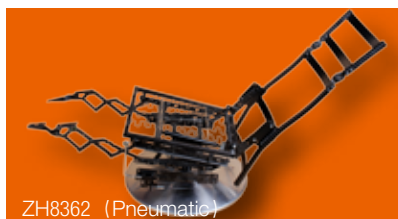

ZH8362 (Pneumatic)



Changzhou Zehui Machinery Co., Ltd
Industry Zone, Zhaigiao, Qianhuang Town, Wujin
District, Jiangsu Province, China

0519-83335279

www.zehuiliftchair.com

sales@zehuiliftchair.com



**Swivel-180°
ZH805**



**Cadmium swivel
ZH8010**

Dimeter: 22" 24" 25" 27" 34"



ZH8011

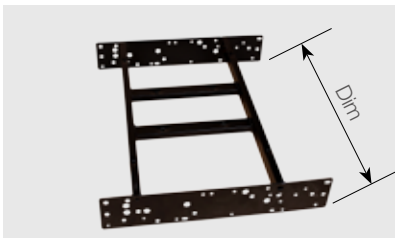

ZH804

Dimeter: 520mm



ZH803

Dimeter: 17"



ZH1010E



**Trolley
ZH806**



ZH806

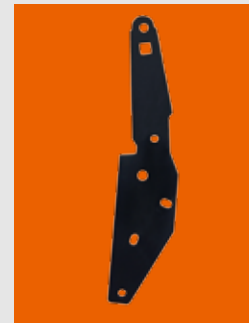

ZH807



ZH808



**KD Bracket
ZH809**

Changzhou Zehui Machinery Co., Ltd
Industry Zone, Zhaigiao, Qianhuang Town, Wujin
District, Jiangsu Province, China

0519-83335279

www.zehuiliftchair.com

sales@zehuiliftchair.com



**Glider Base
ZH1010B**

- Six adjustable seat heights on mounting brackets.
- Seven size widths-allows for greater floor stability and ability to fit on current club chair styles.
- Easy mounting to bottom of leg rails.
- Available for different applications.
- Large-diameter cross tubes provide greater side-to-side stability and torque control.

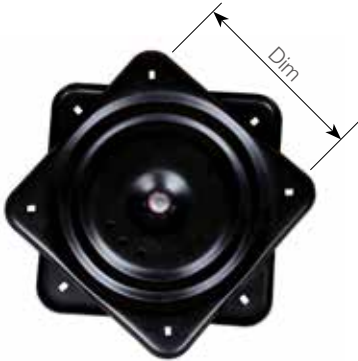

Ring Base

Pre-pressed designed to operate well in state.
Available different types of swivels for different usage made durability and smooth operation.



Swivel and Ring Base Assembly

Ring Bases can be assembled with 8" or 10" swivel.
Swive and Ring Base can be applied to steel-to-the-floor mechanisms.



Adjustable Mounting Heights

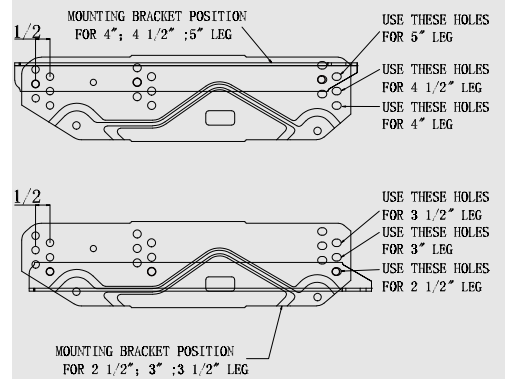

Swivel 360° 10"

Pitch	Flat
Finish	Black
DIM.A	7 61/64"
Recommended Application	Heavy duty, chairs, recliners, gliders

Changzhou Zehui Machinery Co., Ltd
Industry Zone, Zhaigao, Qianhuang Town, Wujin
District, Jiangsu Province, China

0519-83335279
www.zehuiliftchair.com
sales@zehuiliftchair.com



**Gas-operated Backrest
ZH801**

- Full recline is now possible with traditional chair and ottoman styles by using back recline mechanism only;
- Reliable, simple and effective, it has only two moving parts;
- Adapts to inside handle or toggle style activation options;
- Gas cylinder technology has been used extensively in other types of seating for years...Now, it also has a home in upholstery;
- Infinite recline positions;
- Smooth and quiet operation.



**Five Legs Swivel Rocker
ZH802**

- Premium-quality rocker springs.
- Patented pivot for long life and platform rocker feel.
- Optional adjustable rear spring.
- Engineered plastic bushings for quiet, smooth, and durable pivot.
- Smooth steel bearing race.
- High-density molded floor protector feet.
- Heavy-gauge, steel legs, 25" base diameter.
- New spring-retention emboss for noise reduction.

Model	High
ZH802	6"
ZH802	8"



Changzhou Zehui Machinery Co., Ltd
Industry Zone, Zhaigiao, Qianhuang Town, Wujin
District, Jiangsu Province, China

0519-83335279

www.zehuiliftchair.com

sales@zehuiliftchair.com